

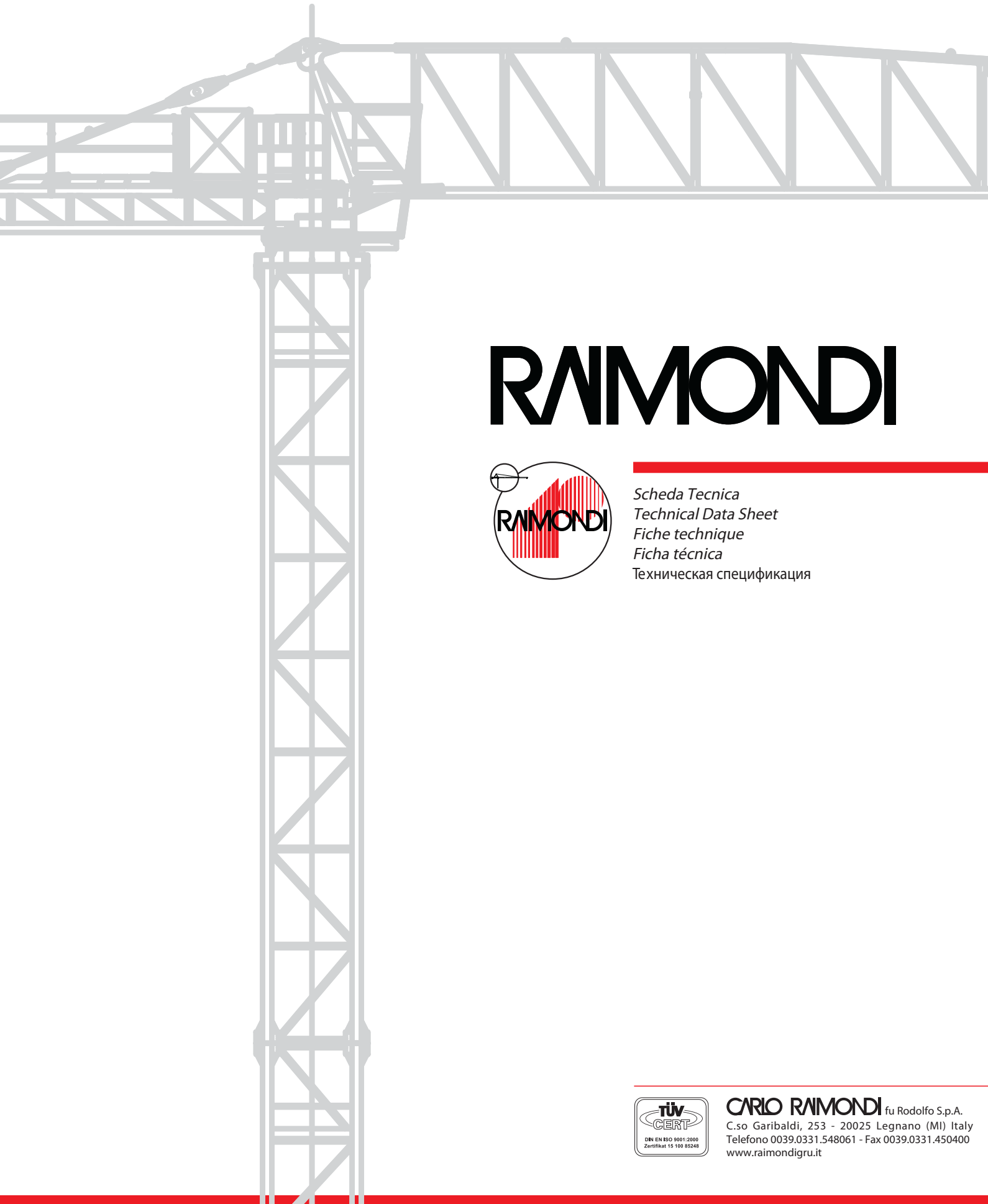

GRU DA CITTÀ - CITY CRANE
CITY CRANE - GRÚA DE CIUDAD
ГОРОДСКОЙ КРАН

ER240



RAIMONDI

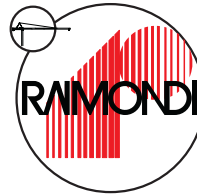

Scheda Tecnica
Technical Data Sheet
Fiche technique
Ficha técnica
Техническая спецификация



CARLO RAIMONDI fu Rodolfo S.p.A.
C.so Garibaldi, 253 - 20025 Legnano (MI) Italy
Telefono 0039.0331.548061 - Fax 0039.0331.450400
www.raidmondigru.it



A4 FEM1,001

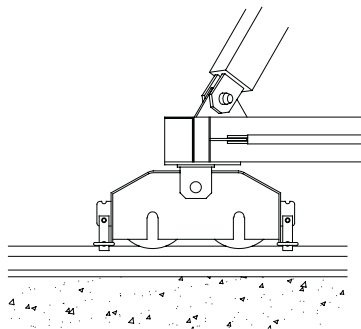
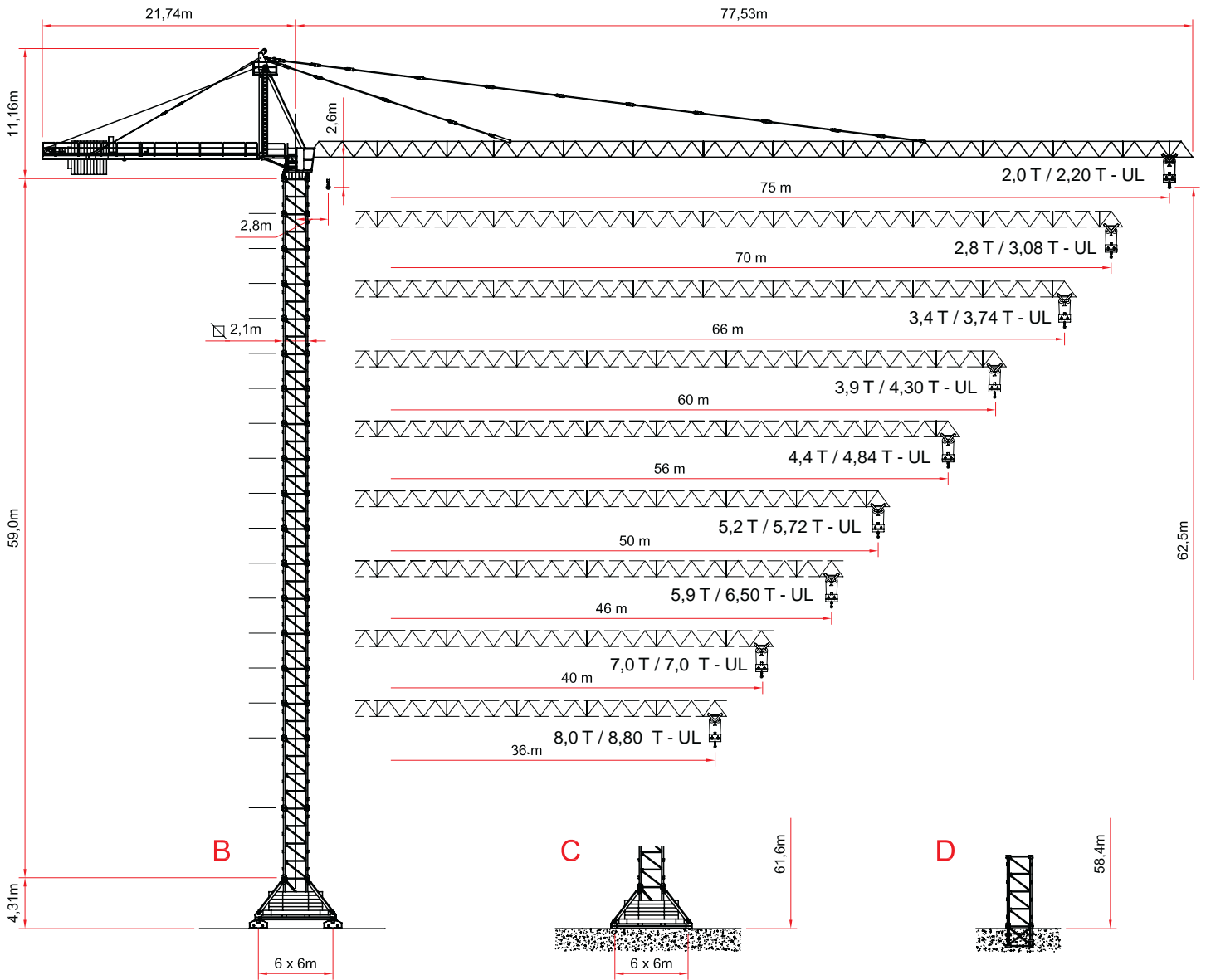

B

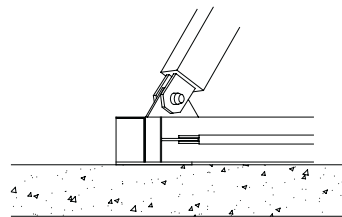

C

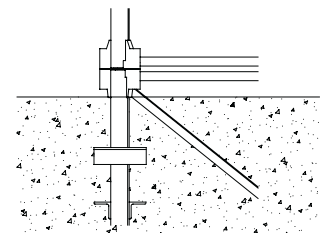

D

UL = ULTRALIFT CONTROL

ALTEZZA SOTTOGANCIO

HEIGHT UNDER HOOK - HAUTEUR SOUS CROCHET - ALTURA BAJO GANCHO - ВЫСОТА ПОД КРЮКОМ

∅ 2,1 - L=6,0 mt.

	H (m)	Z (t)	F1 (kN)	H (m)	Z (t)	F1 (kN)
8	61,6	90,00	1072	8	62,5	90,00
7	55,7	83,54	925	7	56,6	83,54
6	49,8	83,54	808	6	50,7	83,54
5	43,9	77,08	709	5	44,8	77,08
4	38,0	70,62	660	4	38,9	70,62
3	32,1	70,62	639	3	33,0	70,62
(5,9 m)				(5,9 m)		
+2	26,2	70,62	600	+2	27,1	70,62

∅ 2,1 mt.

	H (m)	F2 (kN)	F3 (kN)
8	58,4	1717	1281
7	52,5	1429	1011
6	46,6	1238	866
5	40,7	1172	815
4	34,8	1110	770
3	28,9	1053	729
(5,9 m)			
+2	23,0	862	589

∅ 2,1 / 2,3







	H (m)	F2 (kN)	F3 (kN)
8	94,1	4538	3819
7	88,1	4134	3541
6	82,1	3546	3088
5	76,3	2976	2649
(5,9 m)			
+4	70,3	2632	2135

∅ 2,1 mt.

	H (m)	F2 (kN)	F3 (kN)
9	64,3	2309	1863
8	-	-	-
7	-	-	-
6	-	-	-
5	-	-	-
4	-	-	-
(5,9 m)			
+3	-	-	-

PORTATA



LOAD - CHARGE - ALCANCE - ГРУЗОПОДЪЕМНОСТЬ

Portata max - Max s.w.l. Charge maxi - Alcance máx. Макс. грузоподъемность		 12000 Kg. / 6000 Kg. 									 14000 Kg. / 7000 Kg. 														
Sbraccio / Jib Portée / Alcance Вылет стрелы	m.	36	40	46	50	56	60	66	70	75	36	40	46	50	56	60	66	70	75						
Campo di portata max da Max s.w.l. range from Charge maxi de Rango de capacidad de carga máx. de Макс. Диапазон грузоподъемности от	a to à a до	25,3	24,6	24,1	23,5	23,0	22,3	22,0	20,2	17,1	22,1	21,4	21,0	20,6	20,1	19,5	19,3	17,7	15,0						
Sbraccio (m.) Radius (m.) Portée (m.) Alcance (m.) Вылет стрелы		15	12000	12000	12000	12000	12000	12000	12000	12000	12000	14000	14000	14000	14000	14000	14000	14000	14000						
		16	12000	12000	12000	12000	12000	12000	12000	12000	12000	14000	14000	14000	14000	14000	14000	14000	14000	13179					
		18	12000	12000	12000	12000	12000	12000	12000	12000	11486	14000	14000	14000	14000	14000	14000	14000	13874	11485					
		20	12000	12000	12000	12000	12000	12000	12000	12000	10148	14000	14000	14000	14000	14000	13744	13555	12285	10148					
		22	12000	12000	12000	12000	12000	12000	12000	10999	9066	14000	13672	13392	13058	12710	12319	12148	10999	9605					
		24	12000	12000	12000	11817	11500	11142	10986	9937	8171	12809	12378	12122	11816	11499	11142	10985	9937	8171					
		26	11687	11290	11055	10774	10482	10153	10010	9045	7420	11687	11290	11054	10773	10482	10153	10009	9044	7420					
		28	10731	10364	10146	9885	9615	9311	9178	8284	6780	10731	10363	10154	9885	9615	9310	9177	8284	6780					
		30	9907	9565	9362	9120	8868	8585	8461	7629	6229	9907	9565	9362	9119	8868	8584	8460	7628	6228					
		32	9189	8869	8679	8453	8218	7952	7836	7058	5707	9189	8869	8672	8452	8217	7952	7836	7058	5776					
		34	8559	8258	8079	7867	7646	7396	7288	6557	5320	8558	8257	8079	7866	7645	7396	7287	6642	5382					
		36	8000	7716	7548	7347	7139	6904	6802	6112	4978	8000	7716	7548	7347	7139	7000	6933	6221	5033					
		38		7233	7074	6884	6687	6465	6368	5803	4672		7233	7074	7000	6891	6648	6519	5846	4722					
		40		6800	6649	6469	6282	6071	6000	5471	4398		7000	6948	7000	6501	6270	6148	5509	4443					
	42			6265	6094	6000	5907	5784	5171	4151		6565	7000	6149	5929	5813	5205	4191							
		44			6000	6000	5816	5601	5483	49000	3927		6217	6026	5829	5619	5509	4929	3962						
		46			5900	5722	5527	5322	5210	4652	3722		5900	5726	5538	5338	5232	4678	3754						
		48				5450	5263	5067	4960	4425	3535			5452	5271	5080	4978	4448	3563						
		50					5200	5021	4833	4730	4217	3363			5200	5027	4843	4746	4237	3388					
		52						4798	4617	4518	4026	3205				4801	4625	4531	4043	3227					
		54							4591	4418	4322	3848	3059				4593	4423	4333	3863	3078				
		56								4400	4233	4140	3684	2923				4400	4236	4149	3696	2940			
		58									4060	3972	3531	2727					4062	3978	3541	2811			
		60										3900	3814	3389	2679					3900	3819	3396	2692		
		62											3667	3255	2569						3670	3261	2580		
		64												3529	3131	2467						3530	3135	2475	
		66													3400	3014	2370						3400	3016	2376
		68														2904	2279							2905	2284
70																2800	2194						2800	2197	
72																2113							2115		
74																	2037						2037		
75																		2000					2000		

Con sistema "ULTRALIFT" tutte le portate intermedie sono aumentate del 10%
 All intermediate loads are increased of 10% if the crane is equipped with "ULTRALIFT" control
 Les charges intermédiaires sont augmentées de 10% si la grue est équipée avec contrôle "ULTRALIFT"
 Con sistema ULTRALIFT todas las capacidades de carga intermedias se aumentan un 10%
 При помощи системы ULTRALIFT все промежуточные величины грузоподъемности увеличиваются на 10%

CARATTERISTICHE AZIONAMENTI PRINCIPALI

GENERAL TECHNICAL CHARACTERISTICS - CARACTERISTIQUES DES MECHANISMES DE DISTRIBUTION
CARACTERÍSTICAS ACCIONAMIENTOS PRINCIPALES - ХАРАКТЕРИСТИКИ ОСНОВНЫХ ПРИВОДОВ

		Velocità - Speed Vitesse - Velocidad Скорость	Potenza - Power Puissance - Potencia Мощность
Rotazione - Slewing Orientation - Rotación Вращение		0,26 / 0,48 / 0,7 min ⁻¹	4 x 4 Kw
Carrello - Trolley Chariot - Carro Тележка		13 / 35 / 56 m/min Progressivo - Progressive	6,6 Kw
Traslazione - Rail Translation - Traslación Горизонтальное перемещение		19 m/min	4 x 4 Kw

Tipo Type Тро Тип		Potenza - Power Puissance - Potencia Мощность		Fune - Rope Cable - Cable Трос m.	Marcia Step Vitesse Marcha Передача	V		V	
		CV - ch Ps - hp	kW			Carico - Load Charge - Carga Грузоподъемность	Velocità - Speed Vitesse - Velocidad Скорость	Carico - Load Charge - Carga Грузоподъемность	Velocità - Speed Vitesse - Velocidad Скорость
						Kg.	m/min.	Kg.	m/min.
60 HP - 5/10 VF	60	45	450 LB	1	5000	8	10000	4	
				2	5000	18	10000	9	
				3	5000	30	10000	15	
				4	3500	48	7000	24	
				5	2400	60	4800	30	
				0 - 750 (*)	80 (*)	0 - 1500 (*)	40 (*)		
75 HP - 6/12 VF	75	55	500 LB	1	6000	8	12000	4	
				2	6000	24	12000	12	
				3	6000	40	12000	20	
				4	3600	64	7200	32	
				5	2500	80	5000	40	
				0 - 1000 (*)	104 (*)	0 - 2000 (*)	52 (*)		
75 HP - 7/14 VF	75	55	500 LB	1	7000	8	14000	4	
				2	7000	24	14000	12	
				3	7000	40	14000	20	
				4	3600	64	7200	32	
				5	2500	80	5000	40	
				0 - 1000 (*)	104 (*)	0 - 2000 (*)	52 (*)		
75 HP - 8/16 VF	75	55	450 LB	1	8000	6	16000	3	
				2	8000	20	16000	10	
				3	8000	34	16000	17	
				4	4000	52	8000	26	
				5	2500	70	5000	35	
				0 - 1200 (*)	84 (*)	0 - 2400 (*)	42 (*)		
100 HP - 7/14 VF	100	73,5	700 LB	1	7000	8	14000	4	
				2	7000	30	14000	15	
				3	7000	52	14000	26	
				4	3750	92	7500	46	
				5	2500	136	5000	68	
100 HP - 8/16 VF	100	73,5	700 LB	1	8000	8	16000	4	
				2	8000	30	16000	15	
				3	8000	52	16000	26	
				4	4000	92	8000	46	
				5	2500	136	5000	68	

(*) Velocità regolata automaticamente tramite sensore di corrente

Conforme alla direttiva 2000/14/CE sul livello acustico - In compliance with the 2000/14/CE instruction on noise level - Conforme directive 2000/14/CE sur le niveau acoustique
Conforme con la directive 2000/14/CE sobre el nivel acustico - Соответствует директивам 2000/14/CE, что касается уровня шума

Forza motrice totale Total installed power Puissance totale des moteurs Fuerza motriz total Общая движущая сила	45 kW (60HP)	55 kW (75HP)	73,5 kW (100HP)
	84 kW	94 kW	112 kW











PESI E INGOMBRI

PACKING LIST - LISTE DE COLISAGE - PESOS Y DIMENSIONES - ВЕС И ГАБАРИТНЫЕ РАЗМЕРЫ

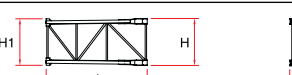
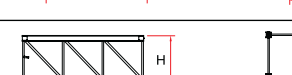
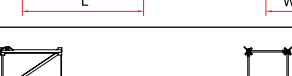
Pos. Item	Pezzi Pieces	Denominazione Description	Schizzo Sketch	Dimensioni Dimensions			Peso Weight		
				L	W	H	Unit	Total	
1	1	Elemento di freccia Jib element Elément deèche Elemento de flecha Элемент стрелы	n° 1		6,200	1,500	1,670	941	-
	2		n° 2-5		6,240	1,500	1,670	895	1790
	1		n° 3		4,240	1,500	1,670	602	-
	1		n° 4		6,240	1,500	1,670	1000	-
	4		n° 6-7 7A-8		6,240	1,500	1,650	745	-
	1		n° 9		6,240	1,500	1,650	813	-
	2		n° 10-11		6,240	1,500	1,630	560	-
	1		n° 12		4,200	1,500	1,610	328	-
	1		n° 13		2,210	1,500	1,610	178	-
	1		Puntale freccia Jib point - Elément pointe Puntal de flecha - Наконечник стрелы		0,740	1,510	0,340	78	-
2	1	Cuspide A frame - Pointe Cúspide - Шпиль		9,500	1,550	0,800	3500	-	
3	1	Elemento controfreccia esterno porta argano sollevamento External counterjib section with hoisting winch Contrefleche extérieure porte treuil Elemento contraflecha externa porta cabrestante elevación Наружный элемент контрстрелы, несущий подъемную лебедку		7,100	2,270	2,040	3600	-	
4	1	Elemento interno controfreccia Internal counterjib section Contrefleche intérieure Elemento interno contraflecha Внутренний элемент контрстрелы		11,830	2,270	1,100	2100	-	
5	1	Controfreccia completa Complete counterjib Contrefleche complète Contraflecha completa Полная контрстрела		18,830	2,270	2,040	7000	-	
6	1	Coda telaio girevole Switchboard support frame Support de l'armoire électrique Cola bastidor giratoria Поворотный хвост станины		2,470	1,700	2,530	1300	-	
7	1	Gruppo rotazione Slewing table Table tournante Grupo rotación Узел вращения		2,300	2,540	2,270	5500	-	
8	1	Ballatoio cabina, cabina access balcony, cabin Porte cabine Balcón corrido cabina, cabina Площадка кабины, кабина		3,450	2,000	2,240	930	-	
9	1	Assieme montato pos. 6-7-8 assembly of pos. 6-7-8 Groupe 6-7-8 Conjunto montado pos. 6-7-8 Монтированный сборочный узел поз. 6-7-8		5,890	4,240	3,350	8180	-	

PESI E INGOMBRI

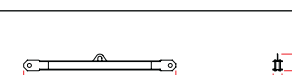
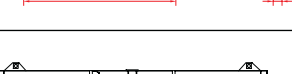
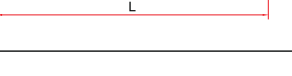
PACKING LIST - LISTE DE COLISAGE - PESOS Y DIMENSIONES - ВЕС И ГАБАРИТНЫЕ РАЗМЕРЫ

Pos. Item	Pezzi Pieces	Denominazione Description	Schizzo Sketch	Dimensioni Dimensions			Peso Weight		
				L	W	H	Unit	Total	
10	11	Blocchi di contrappeso Counterweight block Contre-poids		AW	2,870	1,200	0,275	2022	22242
	1	Bloques de contrapeso Блоки противовеса		BW	1,815	1,200	0,275	1296	-
11	-	Elemento di torre Tower element Elément de mature		GR5	6,000	2,300	2,300	3450	-
12	-	Elemento de torre Башенный элемент			3,000	2,300	2,300	1900	-
13	-	Elemento di torre Tower element Elément de mature		GR6	3,000	2,325	2,320 H1 2,300	3000	-
14	-	Elemento de torre Башенный элемент			6,000	2,325	2,320	5555	-
15	1	Elemento di base Base element Mat de base Elemento de base Элемент основания			3,000	2,400	2,400	1950	-
16	1	Gabbia di montaggio Climbing cage Cage de montage Jaula de montaje Монтажная клеть			8,530	3,100	2,300	7670	-
17	1	Tronchetto di fondazione Expendable foundation element Elément a sceller Tronco de fundación Ствол основания			1,820	2,400	2,400	1370	-
18	4	Gambe di fondazione Fixing angles Pieds de scellement Patas de fundación Ножки основания			1,820	0,470	0,470	280	1120
19	4	Puntoni di base Oblique legs Jambes de force Cabrios de base Стойки основания			3,770	0,230	0,260	340	1360
20	1	Trave principale della crociera di base Base main beam Poutre de chassis de base Viga principal de la cruceta de base Главная балка крестовины основания			8,900	0,720	0,760	1650	-
21	2	Semitrave della crociera di base Half base beam Semipoutre de chassis de base Media viga de la cruceta de base Полубалка крестовины основания			4,350	0,600	0,760	750	1500
22	4	Bilancino di traslazione motorizzato Driven bogie Boggie motorisée Balancín de traslación motorizado Приводной баланси́р горизонтального перемещения			1,750	0,705	0,790	1000	4000
23	1	Blocco di zavorra Base ballast block Lest de base		3G	4,200	0,320	1,400	3230	--
	1	Bloque de lastre Блок балласта		3H	5,200	0,400	1,400	6240	--

RAMPANTE RI - 2,1 / 45

FLOOR CLIMBING
TELESCOPABLE SUR DALLES
RAMPANTE
КОНТРОРС

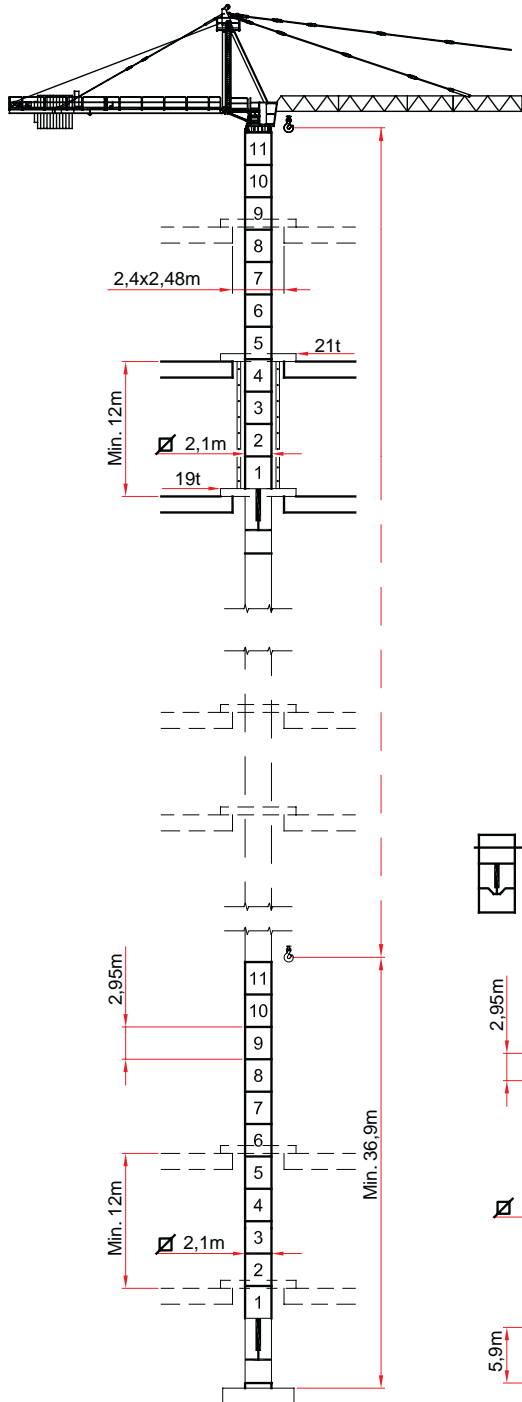

SOPRALZO IDRAULICO HC - 2,1 / 45

EXTERNAL CLIMBING
TELESCOPABLE
SOBREELEVACIÓN HIDRÁULICA
ГИДРАВЛИЧЕСКОЕ ПОВЫШЕНИЕ

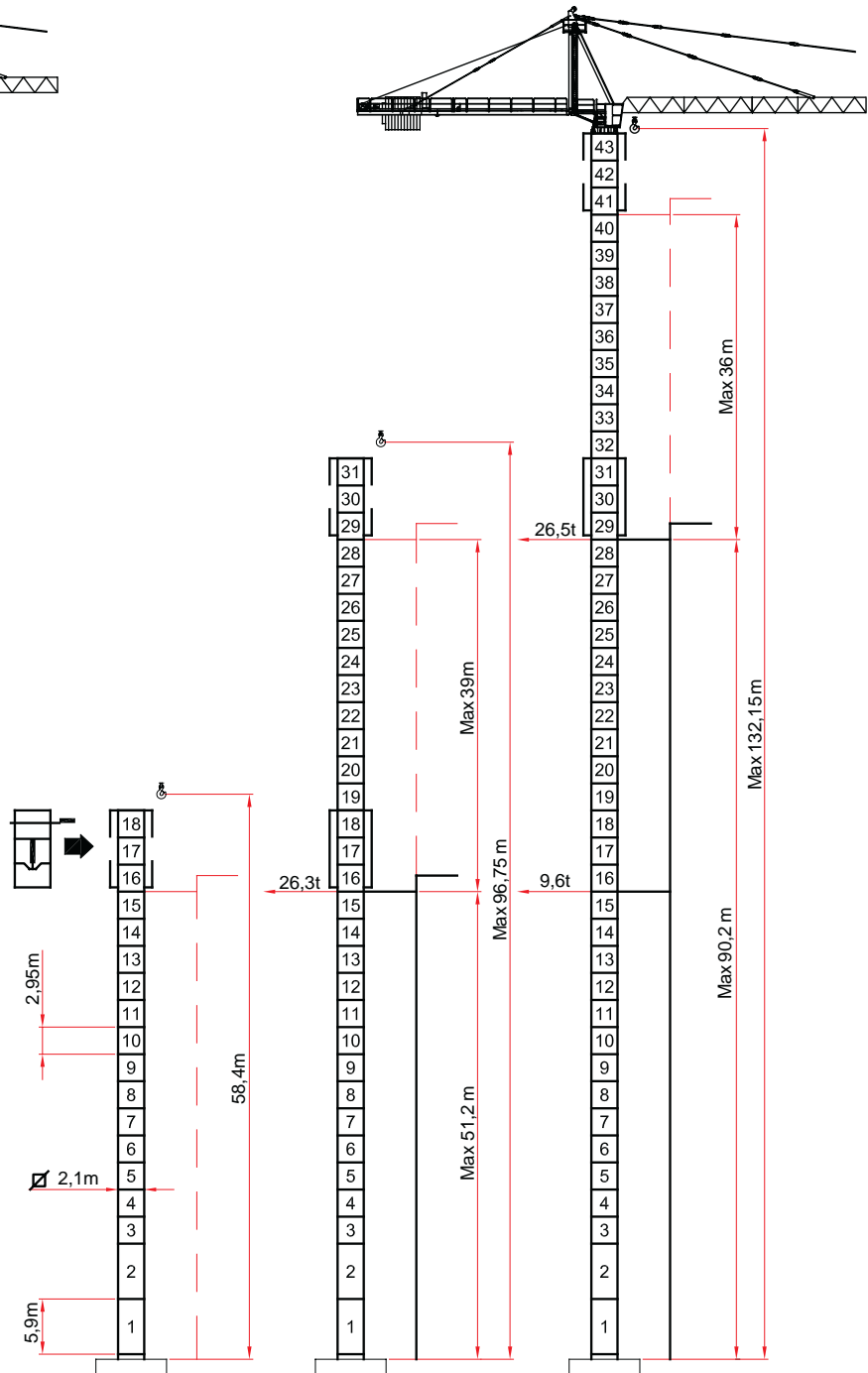

I dati riportati possono essere soggetti a modifiche senza preavviso



CARLO RAIMONDI fu Rodolfo S.p.A.
C.so Garibaldi, 253 - 20025 Legnano (MI) Italy
Telefono 0039.0331.548061 - Fax 0039.0331.450400
www.raimondigr.it